

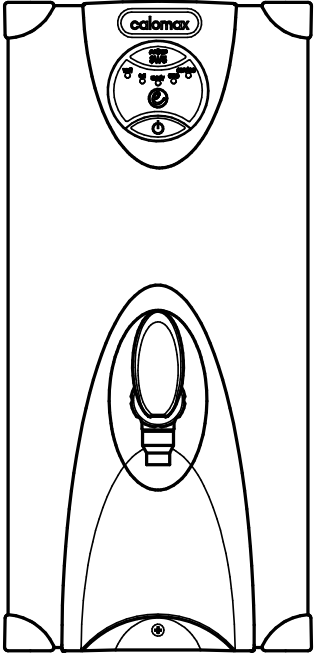

INSTALLATION, OPERATION AND SERVICING INSTRUCTIONS
FOR THE ECLIPSE RANGE OF WATER BOILERS

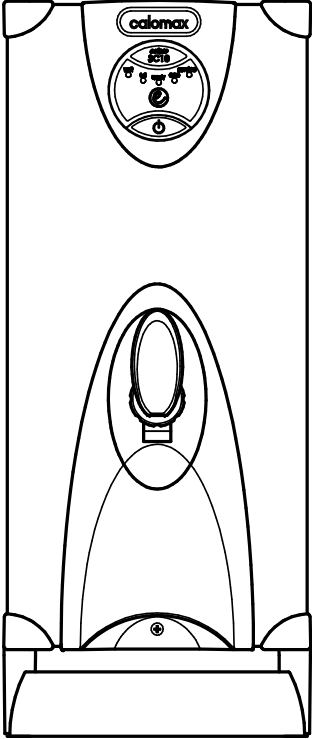

Issue 14
19/04/24
DCR:1143



Please read these instructions carefully before operating your boiler for the first time

Calomax Limited
Lupton Avenue, Leeds LS9 7DD
Tel. 0113 249 6681
email: service@calomax.co.uk www.calomax.co.uk

CONTENTS	PAGE
INTRODUCTION	3
CHECK LIST	3
APPROVALS	3
CONSTRUCTION	4
INSTALLATION	4
LOCATION	4
COLD WATER INLET	5
ACCESS INSTRUCTIONS	6
VENT / OVERFLOW	7
ELECTRICAL CONNECTIONS	8
USER INSTRUCTIONS	8
SCALE	9
GENERAL OPERATION	9
CLEANING	9
TROUBLE SHOOTING	10
ACCESSORIES	11
SPARE PARTS	12/13
EXPLODED DIAGRAM	14/15/16/17
SERVICE INSTRUCTIONS	18/19
GENERAL FUNCTION	20
WIRING DIAGRAM	21
DIMENSIONS AND WEIGHTS	22
WARRANTY	23
PRODUCT SPECIFICATION	24

INTRODUCTION

Thank you for purchasing a boiler from the Calomax Eclipse range. All our products are designed to give years of simple, reliable operation. To ensure this, it is important that the installation and subsequent servicing and maintenance is carried out by a suitably qualified person in accordance with these instructions.

For assistance in finding a suitable engineer in your area, visit our website www.calomax.co.uk, contact our service department on 0113 249 6681 or email: service@calomax.co.uk

CHECK LIST counter top models

Before commencing installation, check that the following parts have been supplied with the boiler:

1. WRAS approved flexible water inlet hose suitable for potable water.
2. Drip tray kit

CHECK LIST wall mounted models

Before commencing installation, check that the following parts have been supplied with the boiler:

1. Wall mounting bracket

APPROVALS



This product conforms to the CE and UKCA marking directive through compliance with the following standards:

- The Low Voltage Directive 73/23/EEC
- The Electromagnetic Compatibility Directive 89/336/EEC

Compliance with these standards has been confirmed through testing by an independent NAMAS approved body.

Any water fittings or water-using appliance connected to the mains water supply must comply with the Water Fittings Regulations (or Byelaws in Scotland). This ensures the appliance does not waste or contaminate the drinking water supply. In order to demonstrate compliance, this product has been submitted to the Water Regulation Advisory Scheme (WRAS) and proven to conform to these regulations.



The tap handle and drip tray (part ref: MDTBK where supplied) have been treated with an antimicrobial additive and independently tested.

CONSTRUCTION

All metallic components of the machine, in direct contact with drinking water are manufactured from high quality 316 grade stainless steel, or non-ferrous materials, providing maximum resistance to corrosion.

INSTALLATION AND MAINTENANCE

LOCATION

The boiler must be installed in a location where access is restricted to operators that are suitably trained, or where untrained operators of the machine can be supervised by trained personnel.

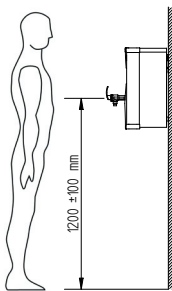

To comply with recommendations from the Health and Safety Executive it is important that due consideration be given to safe operation of the controls of the boiler. The boiler should therefore be mounted in such a manner that the operator can stand directly facing the machine with the controls at a recommended height from the floor to the draw-off tap handle of 1200mm +/- 100mm. Consideration should also be given to the servicing requirements of the machine.

The maximum and minimum ambient operating conditions must be between 35 °C and 5 °C. The appliance is not suitable for installation where a water jet could be used. Install the boiler on a surface or wall suitable for the working weight of the boiler. Allow clearance for ventilation and for the easy removal of the outer casing lid and front panel. Calomax recommend a minimum clearance of 50mm on all sides of the boiler. A suitably qualified engineer must install this unit. Plumbing and electrical installation work may be involved.

WALL-MOUNTED BOILERS ONLY

Hang the boiler on the wall bracket and secure into place with 4th fixing. The electrical cable should be routed as shown. The use of 6mm Rawl-Bolts is recommended to secure the bracket to a wall of appropriate construction to support the working weight of the boiler.

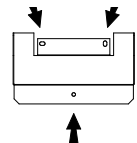

3 point fixing wall bracket for wall mounted range

The water inlet fittings are designed for push-fit connections. Compression fittings can be used if preferred but these should be connected directly to the copper pipe (not the plastic push-fit) using the Ø12-15mm compression reducing sets supplied.

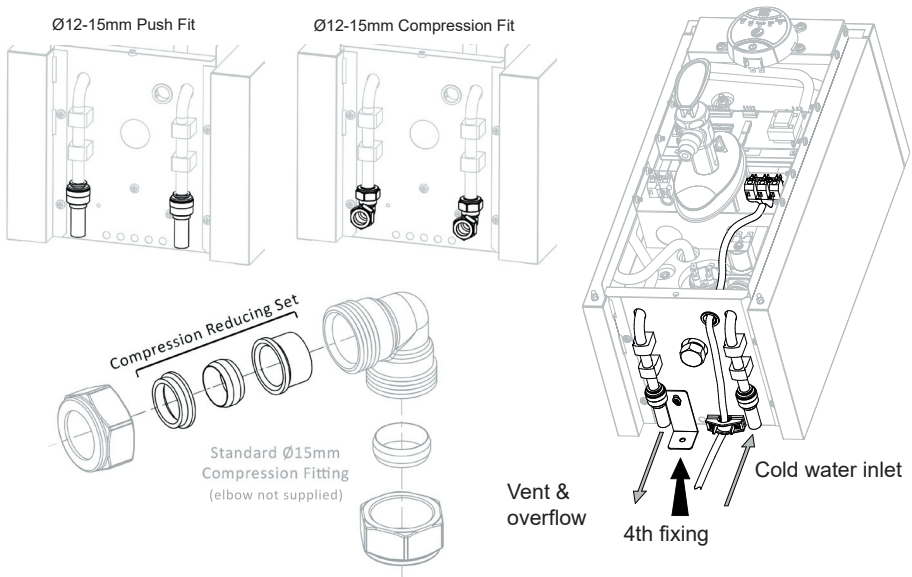

COLD WATER INLET

The boiler must be connected to a potable water supply using the food grade hose where provided, or rigid 15mm pipe in a manner which complies with UK water regulations via an appropriate isolating valve. Always use the new hose supplied (counter-top models only). Do not reuse old hoses. The supply must provide a constant pressure of between 20 KPa and 1000 KPa (0.2 to 10 Bar).

If the water supply contains excessive solids in suspension it is recommended that a fine mesh "in line" water filter is fitted in the pipe work. Failures due to scale and sediment are not covered by the warranty.

TO COMPLY WITH UK WATER SUPPLY REGULATIONS A SINGLE CHECK VALVE MUST BE FITTED.

BEFORE CONNECTING, THE SUPPLY PIPE MUST BE THOROUGHLY FLUSHED OUT TO ENSURE THAT FOREIGN MATTER DOES NOT BLOCK OR ENTER THE SOLENOID VALVE

ACCESS INSTRUCTIONS

Access to the internals of the machine is gained by the removal of the front panel. Prise off the outercasing lid from its mounting clips, remove the top two panel mounting screws and the third bottom mounting screw (where fitted). Remove the cover.

The 3C5C model does not have the third screw. It is fitted with two more clips at the bottom of the panel which can be prised off.

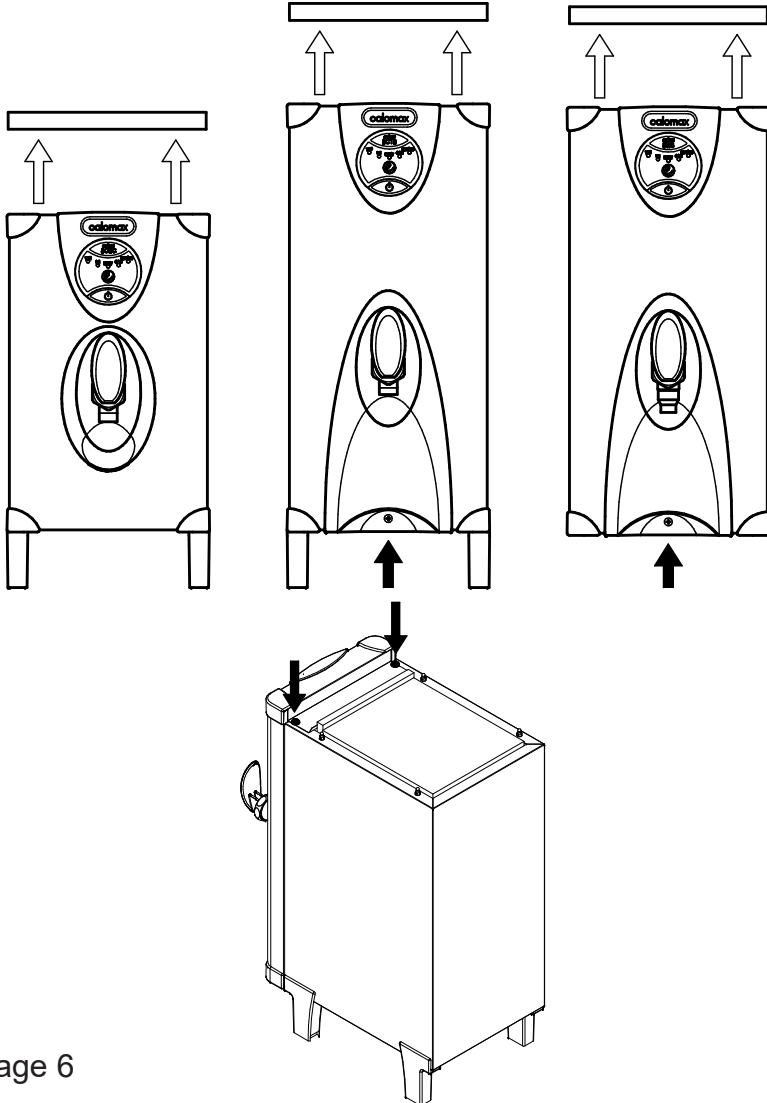

VENT & OVERFLOW

The vent / overflow pipe must be extended and laid with a **continuous fall**, discharging to a safe and visible point. The pipe should not be directly connected to a closed waste, as taste problems may occur and should never be allowed to become blocked or restricted. Ø15mm copper or 'Speedfit' pipe should be used. The drip tray kit provided with the counter top models allow the option of plumbing the overflow pipe to discharge into the drip tray and then plumbing the drip tray to a safe and visible point of discharge. If the machine is operated without the overflow pipe being extended as advised, any subsequent damage incurred will be the responsibility of the installer.

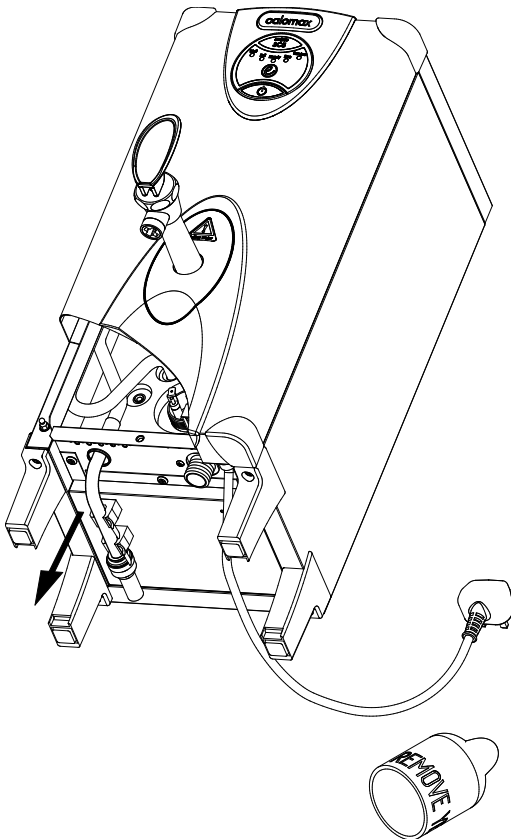

If the boiler is required to drip or overflow into the drip tray, the configuration of pipework may be altered as follows: Remove the machine front panel and unclip the pipework elbow. Carefully pull the elbow in the direction of the arrow, out of the silicone connecting tube on the end of the main water pipe. The silicone connecting tube will now direct water into the drip tray.

The boiler will have a yellow packaging cap on the vent / overflow pipe underneath the boiler. Wall mounted boilers will also have a cap on the water inlet pipe. **THESE MUST BE REMOVED.**

ELECTRICAL CONNECTIONS

The boiler should be connected to a 240V ac 13A electrical supply, capable of carrying a load of 3kW (or 2kW for the 2W3 model). The installation of a residual current device (RCD) having a rated residual operating current not exceeding 30 mA is advisable.

USER INSTRUCTIONS



During normal operation some external parts will become very hot, particularly the tap body. Care must be taken to avoid a burn or scald injury.

This equipment is not intended for use by persons (including children) with reduced physical, sensory or mental capabilities, or lack of experience and knowledge, unless they have been given supervision or instruction concerning use of the appliance by a person responsible for their safety.

Children should **NOT** be allowed to play with or use this appliance.

In the event of the power supply lead to the boiler becoming damaged, the appliance must be removed from service. A replacement genuine part is available from Calomax Ltd, and must be fitted by a suitably qualified engineer.

COMMISSIONING

Turn on the water supply and then switch on the electrical supply.

When the power switch is pressed on the front fascia the Wait light will illuminate and the unit will fill with water (1.3 L/Min). When water reaches the low water level sensor, the element will be energised and the solenoid will continue to fill the boiler to the normal operating water level. At this time the Full light will be illuminated indicating that the machine has reached full capacity of water. When the water has reached the normal operating temperature, the Wait light will extinguish and the Ready light will illuminate. The boiler is now ready for use.

SUBSEQUENT USE

After the boiler has finished the commissioning cycle, and water is drawn from the tap, water will be replenished in short cycles (small amount of water and then heat). The solenoid and element will never be on at the same time unless the boiler is switched off and on again (re-setting commission mode). In normal use the boiler will always be

at operating temperature indicated by the Ready light being illuminated. The full light will be illuminated only when the boiler is full of boiling water. By pressing the symbol  on the upper fascia label, the economy feature is selected. This feature reduces the working capacity of the appliance by approximately half. The Full light will be disabled.

SCALE

The production of scale is a natural phenomenon and commonly occurs in hot water systems. The nature of the scale produced and its rate of formation varies widely throughout the country.

To ensure continuous, reliable operation, the boiler should be regularly de-scaled by a suitably qualified engineer.

The Eclipse boiler benefits from an integral scale inhibitor, **this is not** a scale eliminator and its effects will differ according to the water quality in your area. To ensure trouble free operation, periodically check for scale inside the boiling chamber. De-scaling may be required within the first 12 months. This is not covered under the product's warranty as it is not a fault.

GENERAL OPERATION

- Hold a cup below the tap or place large vessels on the drip tray. Care must be taken to avoid injury through splashing or over-filling.
- To begin filling, pull the handle forward or push it backward – hot water begins to flow. If the tap is opened fully it can be locked open (for filling large vessels). In this state the boiler must never be left unattended.
- To stop filling, release the handle so it returns to the closed position.

CLEANING



Avoid using any abrasive materials. Wiping the outer casing with a damp cloth should be sufficient. Some stainless steel cleaning products may not be suitable for plastic and must not come in contact with the plastic fascia parts. Always disconnect the electrical supply before cleaning.

NEVER USE A SPRAY JET OR ANY OTHER METHOD WHICH COULD CAUSE WATER TO ENTER THE ELECTRICAL CHAMBER.

BASIC TROUBLE SHOOTING

Symptoms	Possible Cause	Remedy
No boiling water available	Broken tap top	Replace tap top (or component)
	Element failed or tripped	Replace element or reset
	Defective Printed Circuit Board	Replace Circuit Board
Overboiling	Excessive internal scale. (See 'De-Scale' page 19)	De-scale the boiler (Particularly thermistor)
	Faulty wiring to thermistor / faulty thermistor	Repair / replace as required
	Temperature controller needs adjusting	Reduce operating temperature
	Element failed to earth	Replace element
	Defective Printed Circuit Board	Replace Circuit Board
Overflows	Dirt in solenoid valve.	Clean solenoid filter or replace solenoid or "work the boiler" -see Service Instructions.
	Level sensors require de-scaling or replacing	De-scale / replace sensors
	Defective Printed Circuit Board	Replace Circuit board

ELEMENT THERMAL CUTOUT

The Eclipse range of boilers has an inbuilt thermal cutout device to protect the element in a boil dry situation. Should the cutout be activated, contact an approved Calomax service provider for advice.

Accessories

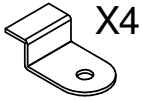

Securing clamp kit
(Counter-top models only)
Ref. MFK



Fused spur time switch
Ref. 7DFST
Max 3 kW



Plug-in time switch
Ref. 7DPIT
Max 3 kW

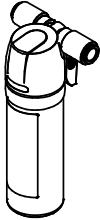

Water filter kit
(To reduce taste & odour problems)
Ref. CWFK

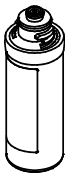

Filter Cartridge
(Replacement filter for kit shown above)
Ref. CWFC1

For more information visit our website at www.calomax.co.uk or call 0113 249 6681

Spare parts are usually available ex-stock.
Please quote Model & Serial Number.

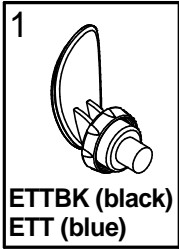

TAP TOP
ASSEMBLY

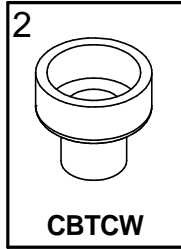

TAP CUP WASHER

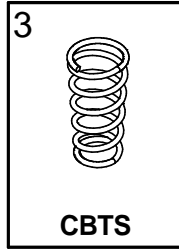

TAP SPRING

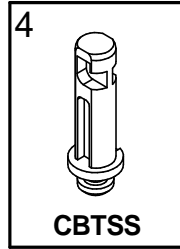

TAP SLOTTED
STEM

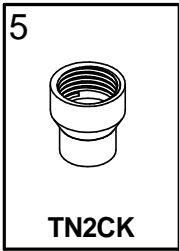

SLOW FILL NOZZLE

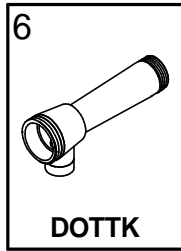

DRAW OFF TAP
BODY

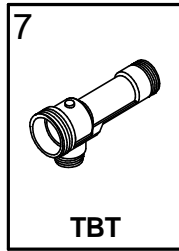

DRAW OFF TAP
BODY

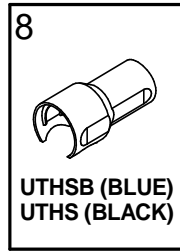

ECLIPSE HEAT
SHIELD

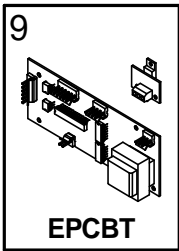

ECLIPSE P.C.B.
TESTED

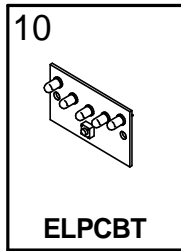

ECLIPSE LIGHT PCB
TESTED

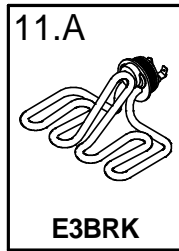

ELEMENT 3KW
RESET KIT

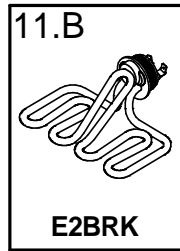

ELEMENT 2KW
RESET KIT

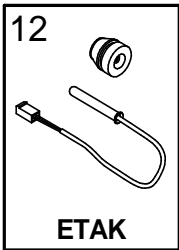

ECLIPSE
THERMISTOR
ASSEMBLY KIT

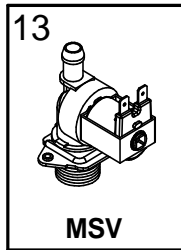

SOLENOID VALVE

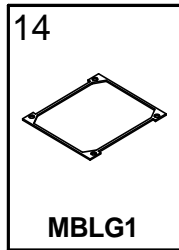

BODY LID GASKET
FOR 3C5C & 3C10
MODEL

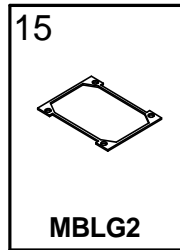

BODY LID GASKET
FOR MODELS
2W3 & 3W5

Spare parts are usually available ex-stock.
Please quote Model & Serial Number.

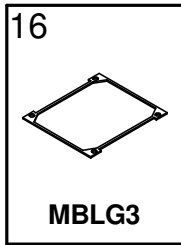

BODY LID GASKET
FOR MODELS
3W7.5 & 3W10

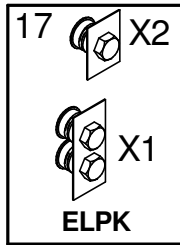

ECLIPSE LEVEL
PROBES KIT

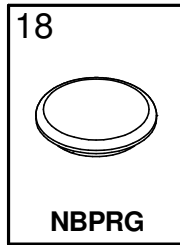

BODY LID GROMMET

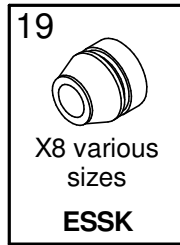

ECLIPSE SILICONE
SEAL KIT

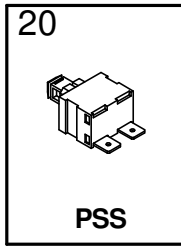

POWER SWITCH



WATER INLET
HOSE

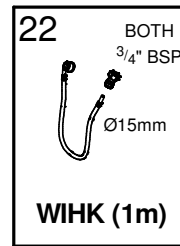

WATER INLET
HOSE

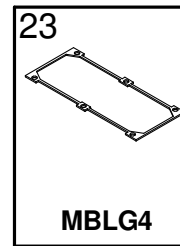

BODY LID GASKET
FOR MODEL
3W15

Exploded parts view for Eclipse wall mounted boilers

(To be read in conjunction with the spare parts list)

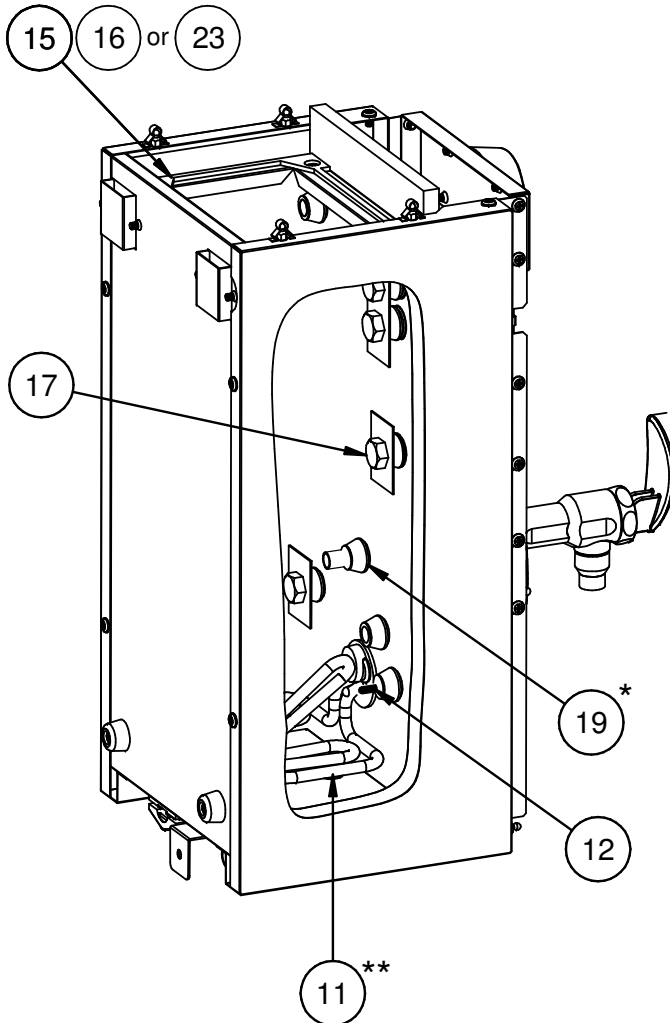

* Complete set of 8 seals (2 sizes)

** 11.A for 3KW models

** 11.B for 2KW models

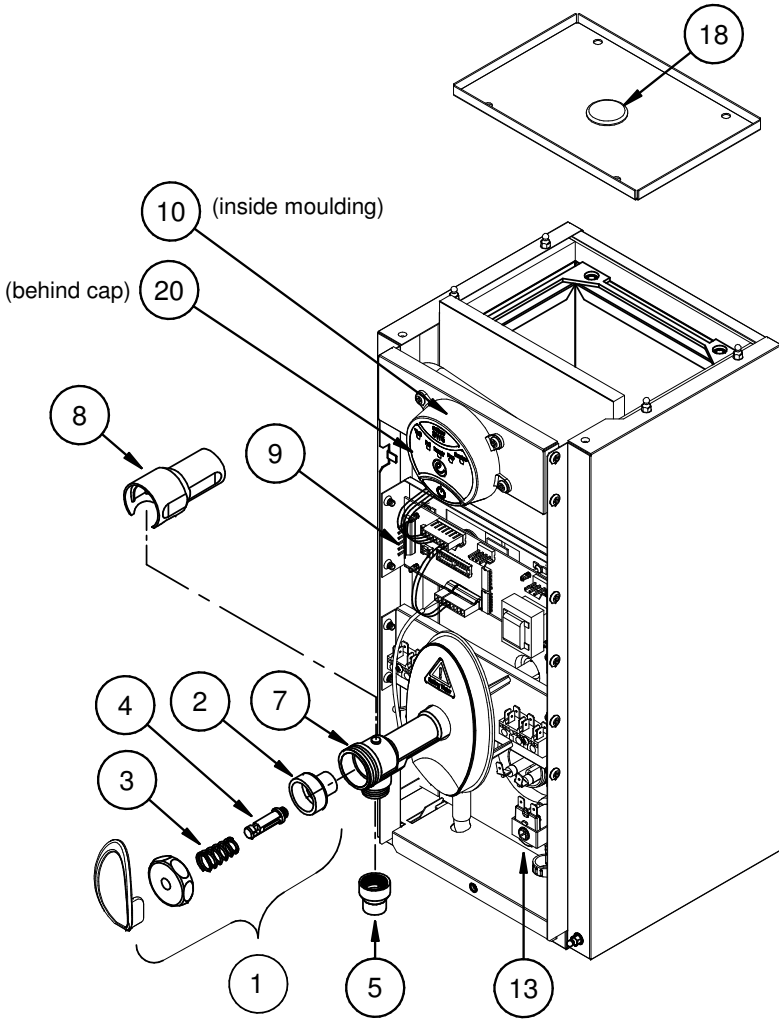

If parts required are not identified, please contact Calomax Limited

Exploded parts view for Eclipse Counter Top Models.

(To be read in conjunction with the spare parts list)

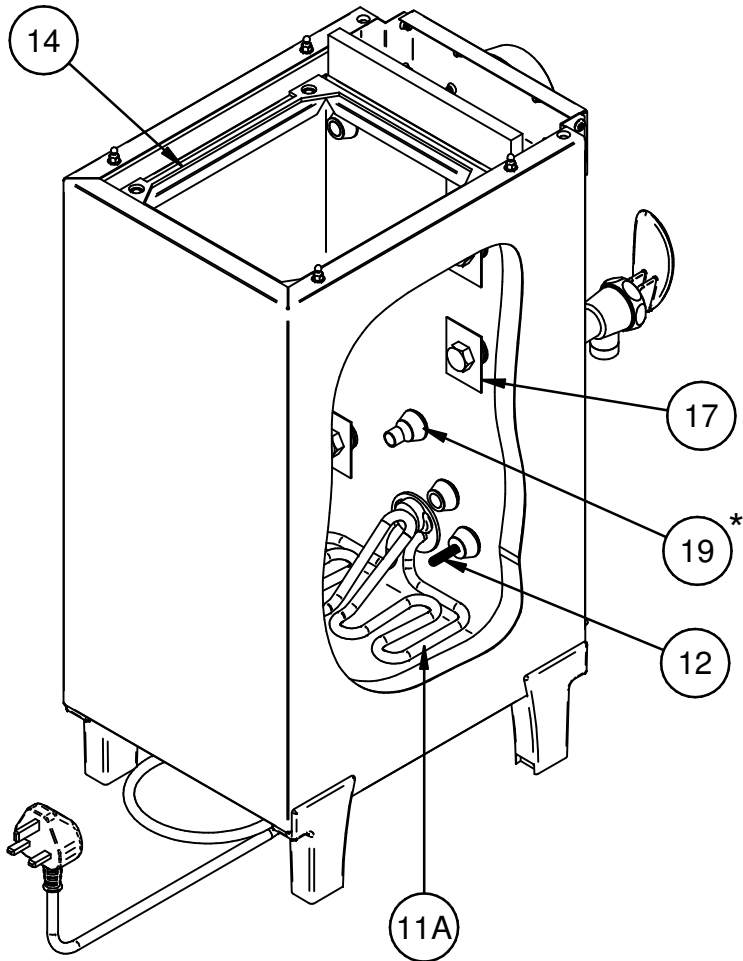

* Complete set of 8 seals (2 sizes)

If parts required are not identified, please contact Calomax Limited

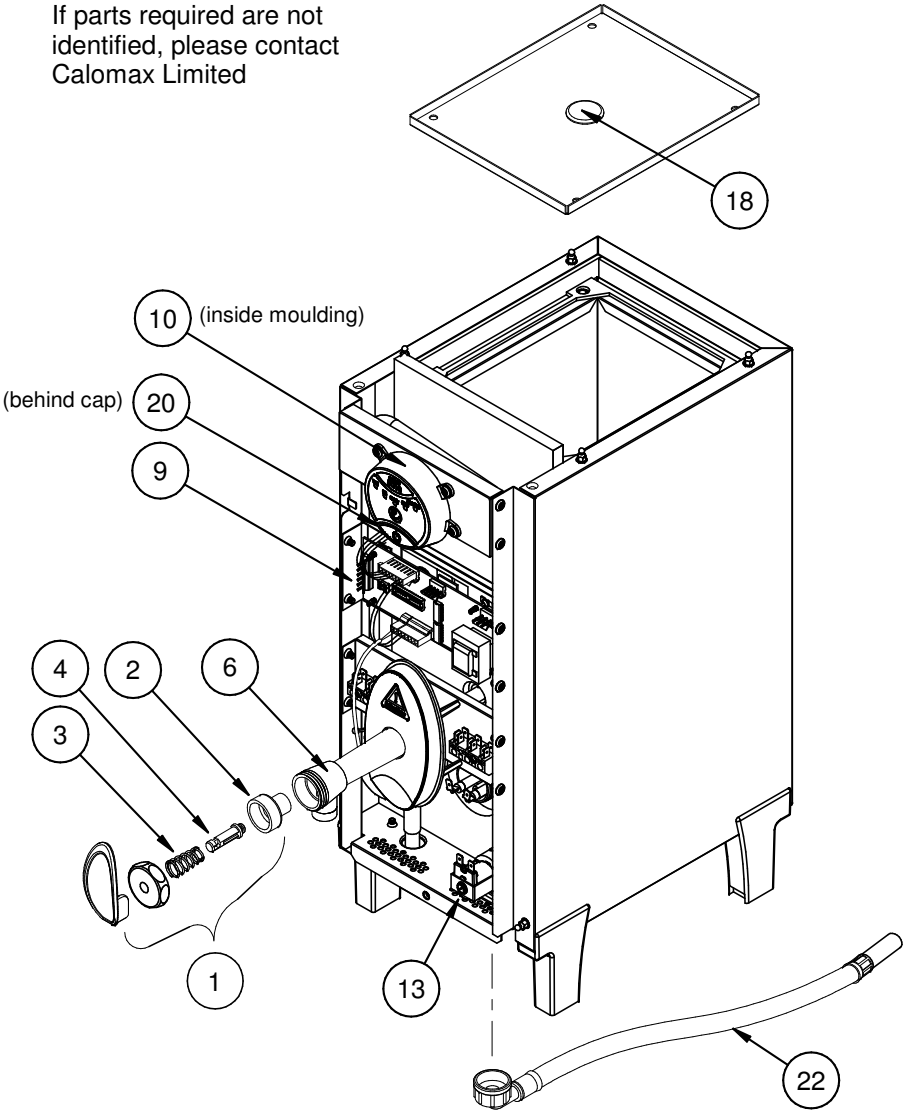

SERVICE INSTRUCTIONS

When a solid red service indicator light on the front of the boiler is illuminated, the machine has been starved of water in excess of 20 minutes and the solenoid valve has been disabled to prevent damage to the solenoid coil through overheat. To re-energise the solenoid, the unit must be disconnected from the electrical supply and then switched back on, after first reinstating the water supply.

If the unit requires servicing the red service indicator will flash a sequence of light pulses. A 2x or 3x-light pulse generally indicates that the low or normal level probes require de-scaling.

A 4x-light pulse means the water level has reached the high level sensor and the likelihood is that the normal level sensor requires de-scaling, or the machine has over-filled due to debris trapped in the solenoid valve. The debris can be removed by drawing plenty of water from the dispense tap, causing the solenoid valve to operate and flush out the obstruction. The machine will reset itself once the problem has cleared. If this does not rectify the problem, turn off the water supply and check for debris in the solenoid valve filter. The unit can be used normally while the service indicator is flashing a 4x pulse. For further assistance, contact our service department on 0113 249 6681 email service@calomax.co.uk or find a local service engineer at www.calomax.co.uk

Access to internal components can be gained by the removal of the outer casing lid and front panel. Once the outer casing is removed, access to the Service Area has been gained. This access must be restricted to persons having knowledge and practical experience of the appliance, in particular as far as safety and hygiene are concerned.

DE-SCALE

To gain access to internals of the water tank, the body lid must be removed. Remove the 4 screws, break the lid gasket seal and lift it clear of the body.

Note: Whenever the body lid has been removed from the boiler a new lid gasket may be required to ensure a steam-tight joint. Damage to the unit caused by a poor lid seal is not covered by warranty.

Scale deposits should be removed from all internal surfaces, particularly the heating element, thermistor and level sensors by gently tapping or scraping. If the deposits are soft, use a nylon pad and flush out. Abrasive cleaning materials containing scouring powders and detergents must not be used, such materials can cause taste problems.

The integral scale-inhibitor of every Calomax boiler allows for a manual / chemical-free descale. Caustic chemical de-scalents should not be used.

IMPORTANT Before re-commissioning the boiler it is important that all scale and moisture is removed from the level sensors and insulating gaskets, to avoid a false signal being transmitted through the scale to the boiler body. Failure to remove this scale and/or moisture will cause the sensor to indicate to the PCB that water is covering the element, whether or not water is present. In this situation the PCB will energise the element causing failure. If in doubt, protect the element by hand filling with water to the level of the draw-off tap before switching on the electrical supply to the boiler.

GENERAL FUNCTION

The printed circuit board (PCB) controls the heating and filling functions of the boiler by monitoring the thermistor and level sensors. The PCB also controls the external light unit to indicate the current state of the boiler. Red and yellow LED'S on the circuit board indicate whether the PCB has energised the element or solenoid respectively.

Should an element fail and need to be replaced, it may be necessary to replace the lid gasket to ensure a reliable steam-tight seal. **Note: the element has a permanent 'Live' feed, and the 'Neutral' is switched.**

PRINTED CIRCUIT BOARD REPLACEMENT

In the unlikely event of a PCB failing and a replacement being required, full instructions will be supplied. It is important to note however, that the Triac PCB must be securely mounted against the copper heat-sink to ensure reliable heat dissipation. Heat transfer compound is also supplied with all replacement circuit boards.

ADJUSTING THE WATER TEMPERATURE SET POINT

The temperature potentiometer (Pot) is pre-set at Calomax and will only require adjustment in exceptional circumstances. Contact Calomax for advice.

Water boils at different temperatures depending on barometric pressure. The temperature should not be tuned higher than 98°C, or over boiling may occur during low barometric pressure conditions.

Wiring Schematic for Eclipse Range Water Boilers

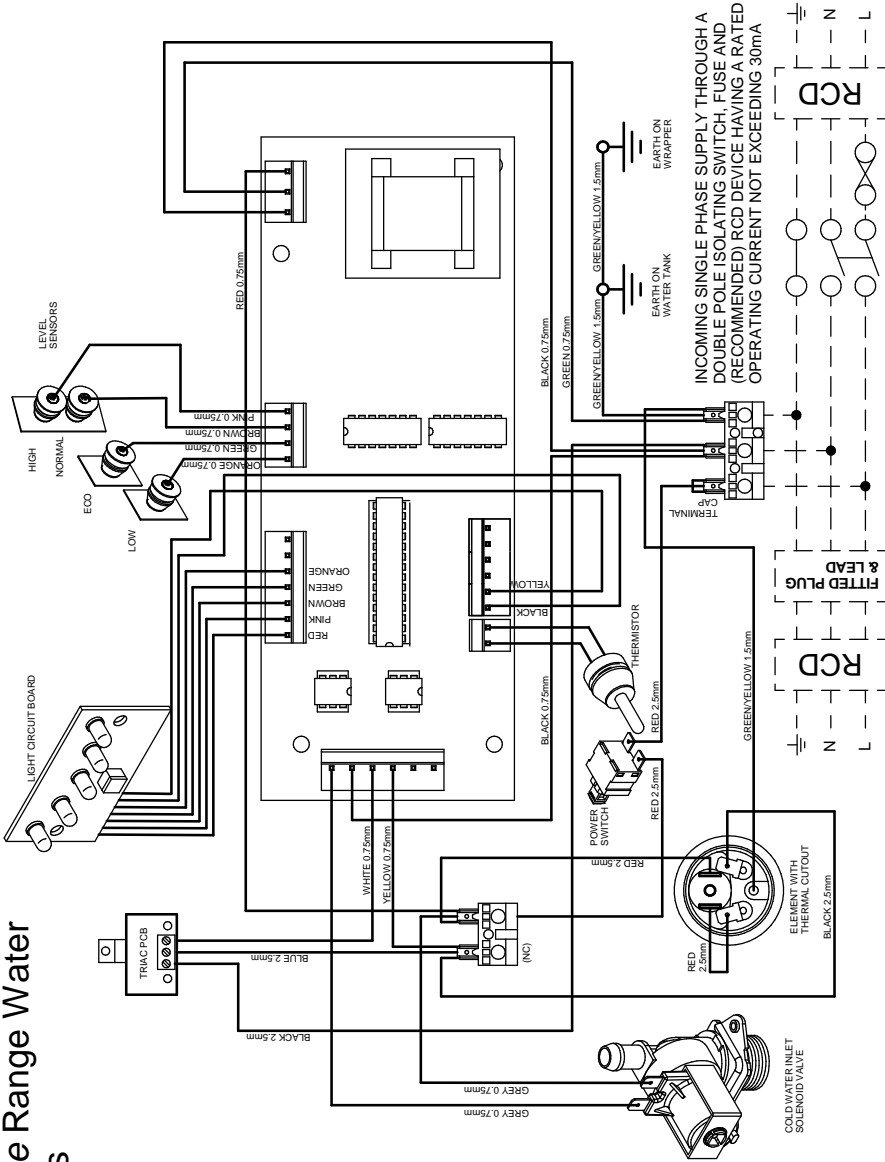

DIMENSIONS AND WEIGHTS

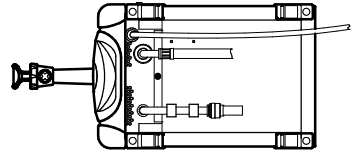
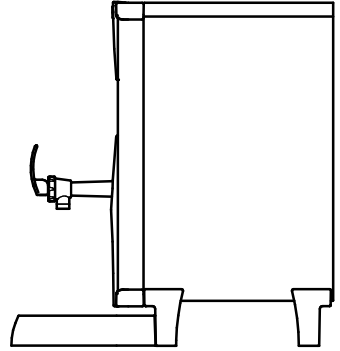
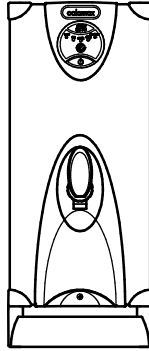

MODEL	3C5C	3C10
Height (mm)	443	570
Depth (mm)	355	355
Width (mm)	240	240
Drip tray clearance (mm)	150	175
Working weight (Kg)	20	30.5

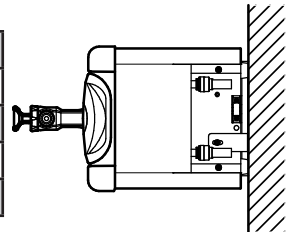
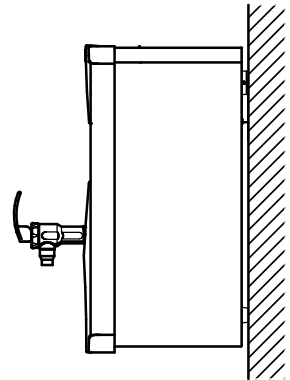
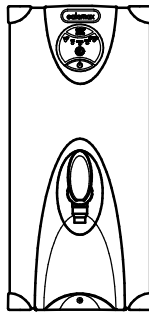

MODEL	2W3	3W5	3W7.5	3W10	3W15C
Height (mm)	435	510	610	610	610
Depth (mm)	270	270	270	270	270
Width (mm)	240	240	270	270	370
Working weight (Kg)	18	21	28	30.5	35

WARRANTY GUARANTEE (UK Mainland customers only)

Calomax have manufactured water boilers in the UK for over 70 years. We are proud of our products and the back-up service we provide.

Properly maintained and serviced, a Calomax boiler should last many years and we have no hesitation in providing a 2 year warranty.

Some factors are beyond our control and would invalidate the warranty offered. These include:

- Incorrect installation
- High / Low water pressure
- Incorrect voltage supply
- Accidental damage
- Limescale build-up

The last item can be a particular problem for water dispensing equipment in hard-water areas. All hot water equipment should be serviced and de-scaled by approved organisations on a regular basis to avoid a damaging build-up of limescale.

Although our boilers incorporate scale-inhibitor technology, we recommend that a taste, odour and scale filter should be fitted where appropriate.

Please visit our website www.calomax.co.uk for details of our Service Partner Network and the range of filters and accessories available.

PLEASE ENTER MODEL & SERIAL NUMBER FOR FUTURE REFERENCE

Model		
Serial Number		
Draw - off capacity	3C5C 3C10 2W3 3W5 3W7.5 3W10 3W15C	5 Litres 10 Litres 3 Litres 5 Litres 7.5 Litres 10 Litres 15 Litres
Heat - up time (First fill to full capacity)	3C5C 3C10 2W3 3W5 3W7.5 3W10 3W15C	21 Minutes 34 Minutes 22 Minutes 21 Minutes 25 Minutes 30 Minutes 36 Minutes
Voltage		220 - 240 V ac 50-60 Hz
Power rating	Model 2W3 All other Models	2kW (MAX) 3kW (MAX)

Note: All measurements are approximate

PLEASE CONTACT OUR SERVICE DEPARTMENT FOR ASSISTANCE

Calomax Limited, Lupton Avenue, Leeds LS9 7DD

Tel: 0113 249 6681

email: service@calomax.co.uk